

PORTABLE HYDRAULIC POWER UNIT

MODEL HT25DYS

The HT25DYS power unit is driven by a Yanmar Diesel T4F engine and is designed to drive several of our pump models including the S3CML, S3VHL, S4T, S4CSL, S4SCR, S4SHR and S8M. A built-in fuel tank allows this unit to run up to 24 hours between refills. Other hydraulic tools and equipment may also operate from this power unit.



FEATURES

- Highway Trailer Chassis with Built-In Fuel Tank and Independent Suspension
- Single Point Lifting Bracket
- Engine Safety Shutdown Package
- Gear or Vane Type Hydraulic Pump
- Hydraulic Oil Cooler
- Variable Speed Throttle Control
- Spin-On Return Filter W/ Indicator
- Tank Top Filler/ Strainer
- System Relief Valve
- Made in USA
- Liquid Filled Pressure Gauge
- Fluid Level/ Temperature Gauge

OPTIONS

- Skid Frame
- Multiple Hydraulic Circuits
- Other Flow and Pressure Combinations

A0116

Model HT25DYS Overall Dimensions

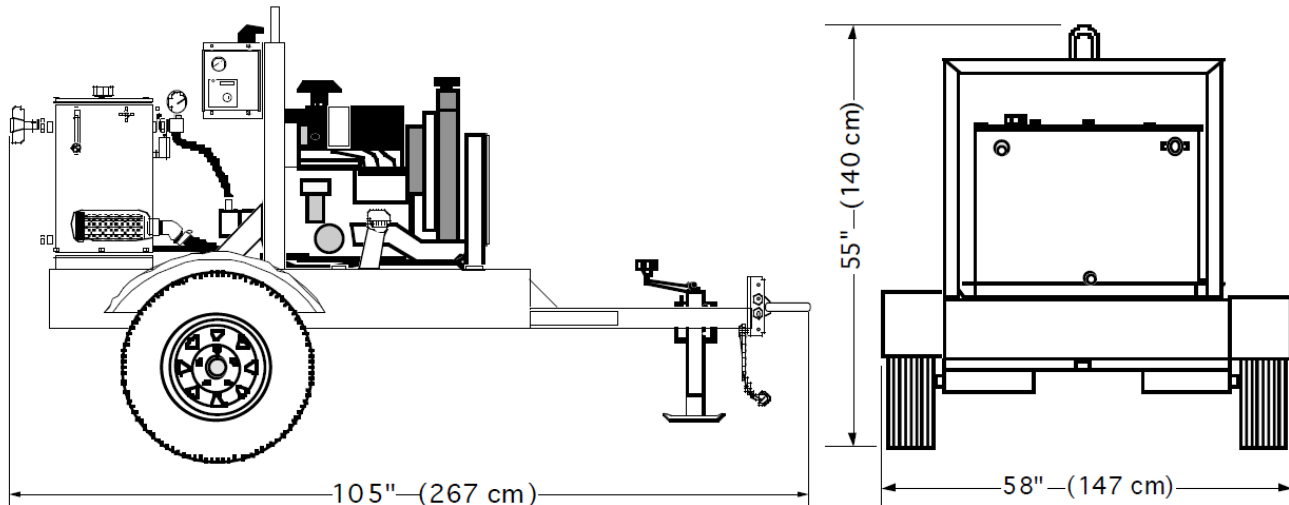

SPECIFICATIONS

ENGINE:..... Yanmar 3TNV88C Liquid Cooled Diesel (Tier 4 Final)
POWER:..... 22 HP(16 KW) @ 3000 RPM
HYDRAULIC OUTPUT*:..... Variable, Max. 12 GPM (45 LPM)
OPERATING PRESSURE*:..... Maximum 2500 PSI (172 Bar)
HOSE PORT SIZE:..... 3/4" NPT
HYDRAULIC OIL:..... SAE 10W or 20W (ISO 32 or 46) Type AW
..... also: Biodegradable oil (Consult Factory)
OIL FILTRATION:..... 10 Micron (Standard)
OIL RESERVOIR CAPACITY:..... 30 U.S. Gallons (113 Liters)
FUEL TANK CAPACITY:..... 42 U.S. Gallons (159 Liters)
FUEL CONSUMPTION:..... Approx. 2.0 U.S. Gal/Hr (7 Liters/Hr)
DIMENSIONS:..... H 55" (140 cm) x W 58" (147 cm) x L 105" (267 cm)
WEIGHT (Dry):..... 1245 lbs. (565 kg)

* For Flows and Pressures Other Than Standard, Consult Factory

Since we are constantly working to improve our products, specifications are subject to change without notice.



167 Stock Street, Nesquehoning, PA 18240 Phone: 570-645-3779 Fax: 570-645-4061

Website: www.hydra-tech.com

E-Mail: htpump@hydra-tech.com