

4" HYDRAULIC SUBMERSIBLE VORTEX FLOW TRASH PUMP

MODELS

S4THL (Aluminum Body)

S4THLDI (Ductile Iron Body)

4" (10 cm) Discharge

Powerful and durable, the S4THL has proven to be an excellent sludge pump. Primary uses for this pump are: oil refinery wastes, sewage digester clean-out, water waste sludge and desilting applications using divers. This versatile pump offers solids handling and high head capabilities. Shut off head at 200 feet.



CE

FEATURES

- Fully Recessed SS Vortex Impeller (will pass 3 1/2" semi-solids)
- Wide Range of Applications & Performance
- Variable Speed hydraulic drive
- Oil Lubricated Seals (can run dry)
- SS wear ring and wear plate
- Can be bolted directly into a pipeline or fitted with a suction hose for underwater dredging
- Tungsten Carbide Coated wear parts, available as an option
- Operates with our HT50 to HT75 power units or other hydraulic power sources capable of flows of 15 - 30 GPM
- Stainless Steel model available

D0516

SPECIFICATIONS

WEIGHT: (Aluminum).....	209 lbs. (95 kg)
(Ductile Iron).....	294 lbs. (133 kg)
HEIGHT:.....	34 1/2" (88 cm)
WIDTH (@ widest point):.....	25 1/2" (65 cm)
DISCHARGE:.....	4", 125# ASA Flange
INLET FLANGE:.....	4", 125# ASA
SOLIDS HANDLING:.....	3 1/2" (9 cm)
HOSE PORTS:.....	1" (-16) SAE
PUMP BODY: (S4THL).....	Heat Treated Aluminum
(S4THLDI).....	Ductile Iron
IMPELLER:.....	Stainless Steel
WEAR RING and WEAR PLATE.....	Stainless Steel
SHAFT:.....	Stainless Steel
SHAFT SEAL:.....	Carbon/Ceramic (Std)
	Silicon Carbide (Optional)
ELASTOMERS:.....	Buna N (Std)
HYDRAULIC OIL:.....	214-320 s.s.u. @ 100°F (64°C)
INPUT FLOW:.....	Max 30 GPM (114 LPM)
OPERATING PRESSURE:.....	Max 3000 PSI (204 Bar)
POWER SOURCE:.....	Any Open Center Hydraulic System

Specifications are subject to change without notice

Model S4THL Overall Dimensions

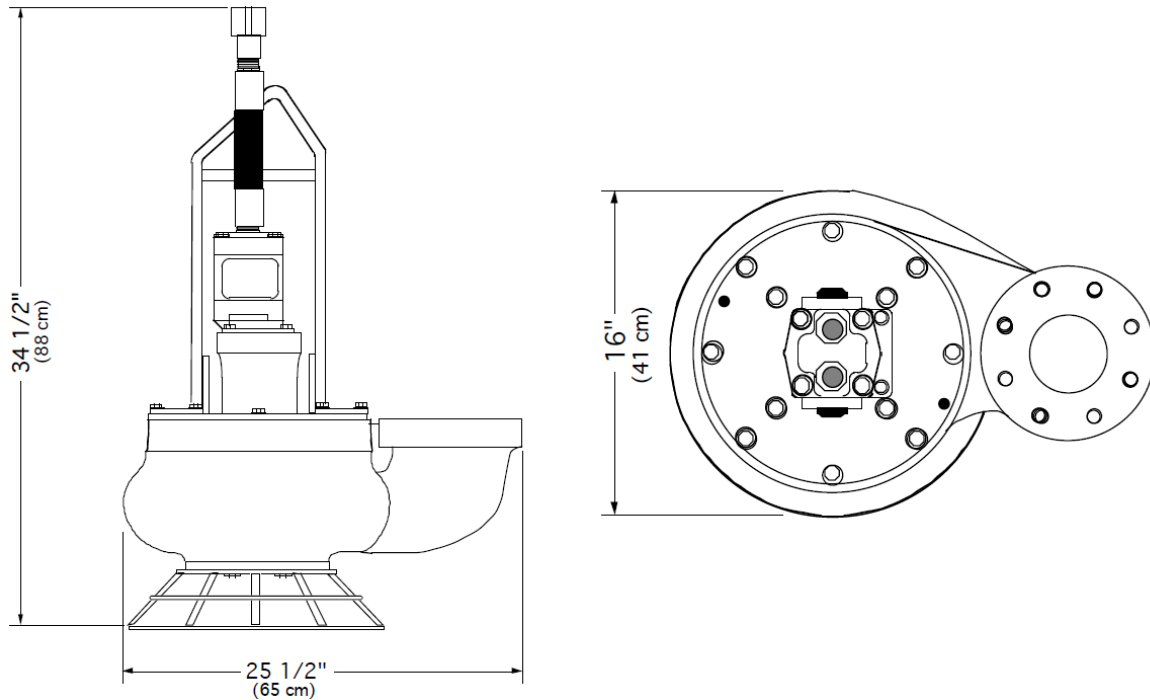

S4THL Typical Performance

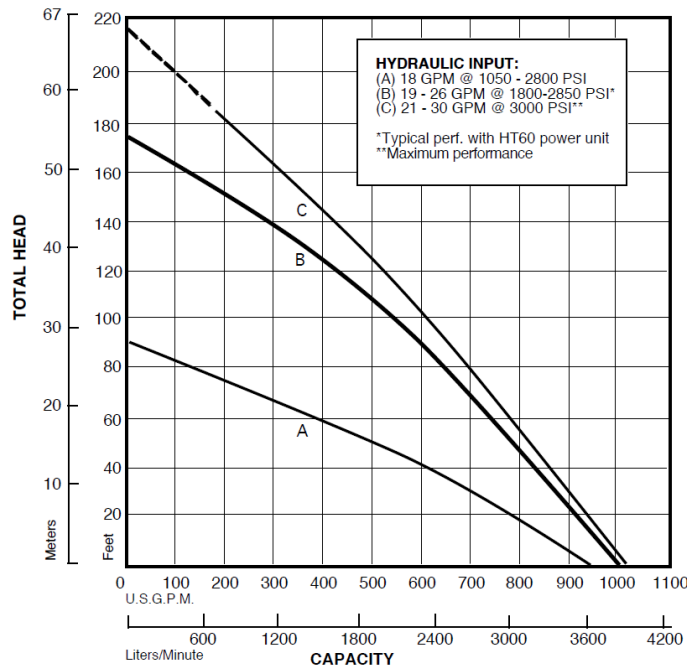

Curves are based on pumping water at 60°F. For performance curves other than shown above, consult factory.

