

4" HYDRAULIC SUBMERSIBLE SAND/ SLURRY PUMP *with Agitator*

MODEL

S4CSL

4" (10 cm) Discharge

The S4CSL pump is designed to use in applications requiring settled solids to be put into suspension and pumped with the discharge water. Primary applications include de-silting ponds, lakes and streams. Other jobs may include filling sand bags to prevent beach erosion, tank and digester cleaning or pumping sediment from caissons. Excellent for controlling sediment around beach slips.



FEATURES

- Hardened Alloy Wear Parts
- Built-in Agitator for stirring up solids
- Oil Lubricated Seals (can run dry)
- Variable Speed hydraulic drive
- Small Size allows pump to fit through a 17 inch opening
- Safe Hydraulic Drive can be used where electric power is hazardous or impractical
- Dependable gear type hydraulic motor
- Operates with our HT20 to HT35 power units or other hydraulic power sources capable of flows to 15 GPM

SPECIFICATIONS

WEIGHT:..... 273 lbs. (124 kg)
 HEIGHT:..... 31" (79 cm)
 WIDTH (@ widest point):..... 16 1/4" (41 cm)
 DISCHARGE:..... 4" NPT
 SOLIDS HANDLING:..... 1 1/2" (4 cm)
 HOSE PORTS:..... 1/2" and 3/4" NPT (F)
 VOLUTE*:..... Hardened Ductile Iron
 IMPELLER:..... High Chrome Alloy
 WEAR PLATE..... High Chrome Alloy
 AGITATOR:..... High Chrome Alloy
 SHAFT:..... 304 Stainless Steel
 SHAFT SEALS: (upper)..... Carbon/Ceramic
 (Lower)..... Silicon Carbide
 HYDRAULIC OIL:..... 214-320 s.s.u. @ 100°F (64°C)
 INPUT FLOW:..... Max 15 GPM (57 LPM)
 OPERATING PRESSURE:... Max 2500 PSI (170 Bar)
 POWER SOURCE:... Any Open Center Hydraulic System

* Optional NI-Hard volute available for highly abrasive applications

D0516

Specifications are subject to change without notice

Model S4CSL Overall Dimensions

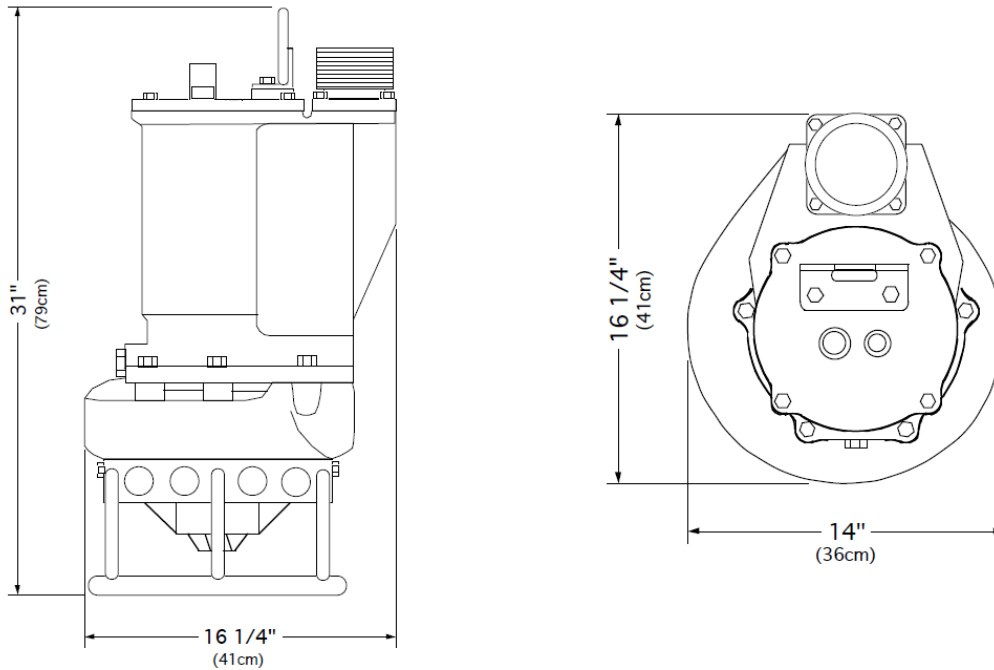

S4CSL Typical Performance

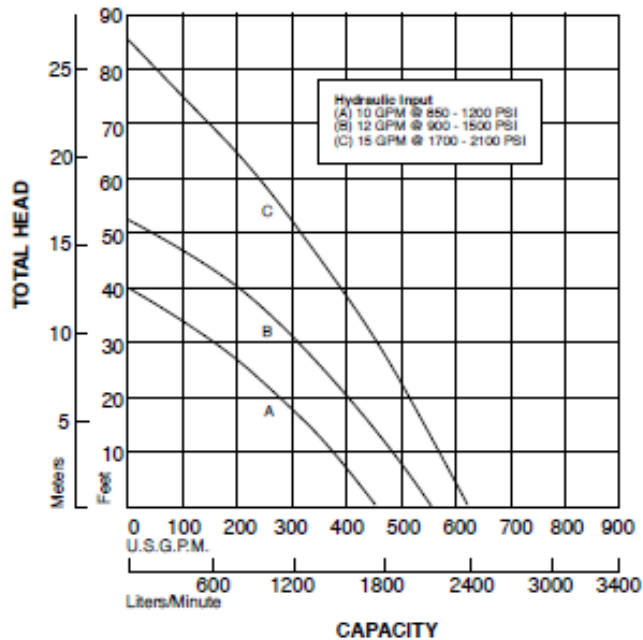

Curves are based on pumping water at 60°F. For performance curves other than shown above, consult factory.